

PIANO COVID-19 CONCORSI

Corso Inghilterra 7 - Torino

SALA STEMMI

Capienza: 13 + 2

N.B.: il rispetto delle distanze indicate andrà preliminarmente verificato in loco

LEGENDA



Percorso principale



Ingresso sala



Banchi

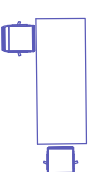

Tavolo commissione

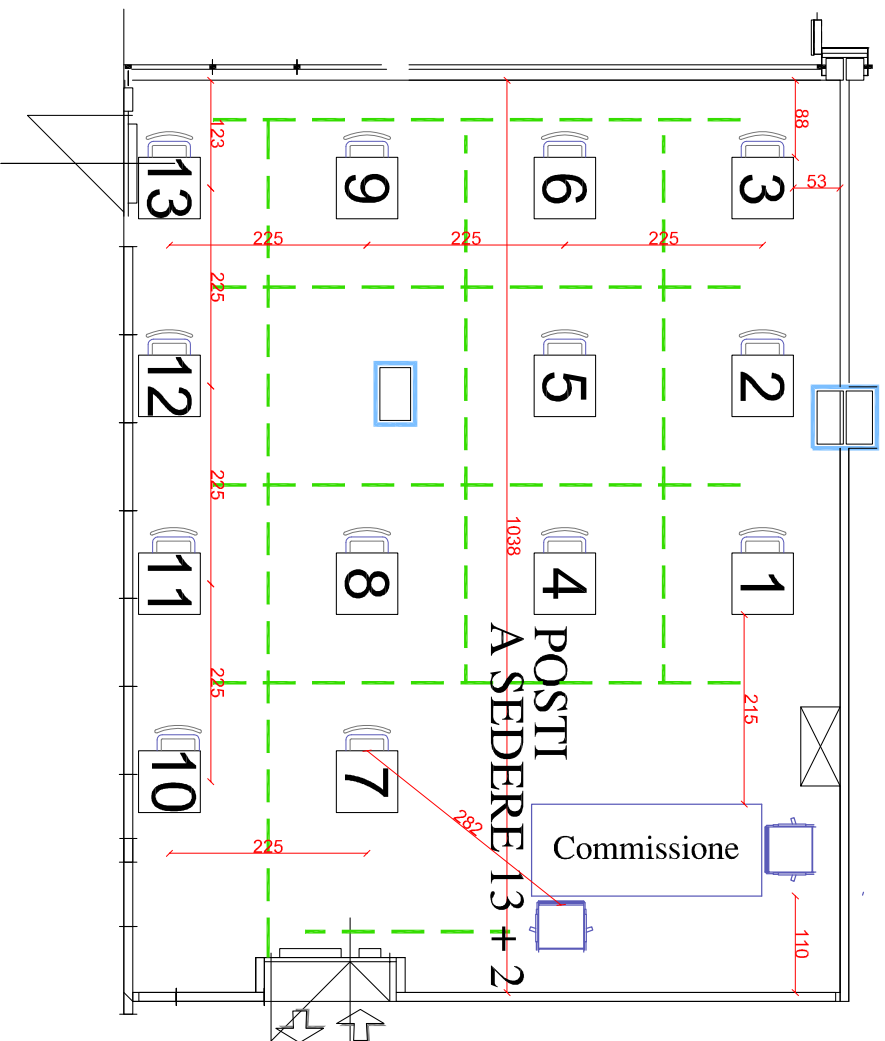

PIANO COVID-19 CONCORSI

Corso Inghilterra 7 - Torino

SALA DEI COMUNI

Capienza: 13 + 2

N.B.: il rispetto delle distanze indicate andrà preliminarmente verificato in loco

LEGENDA



Percorso principale



Ingresso sala



Banchi



Tavolo commissione

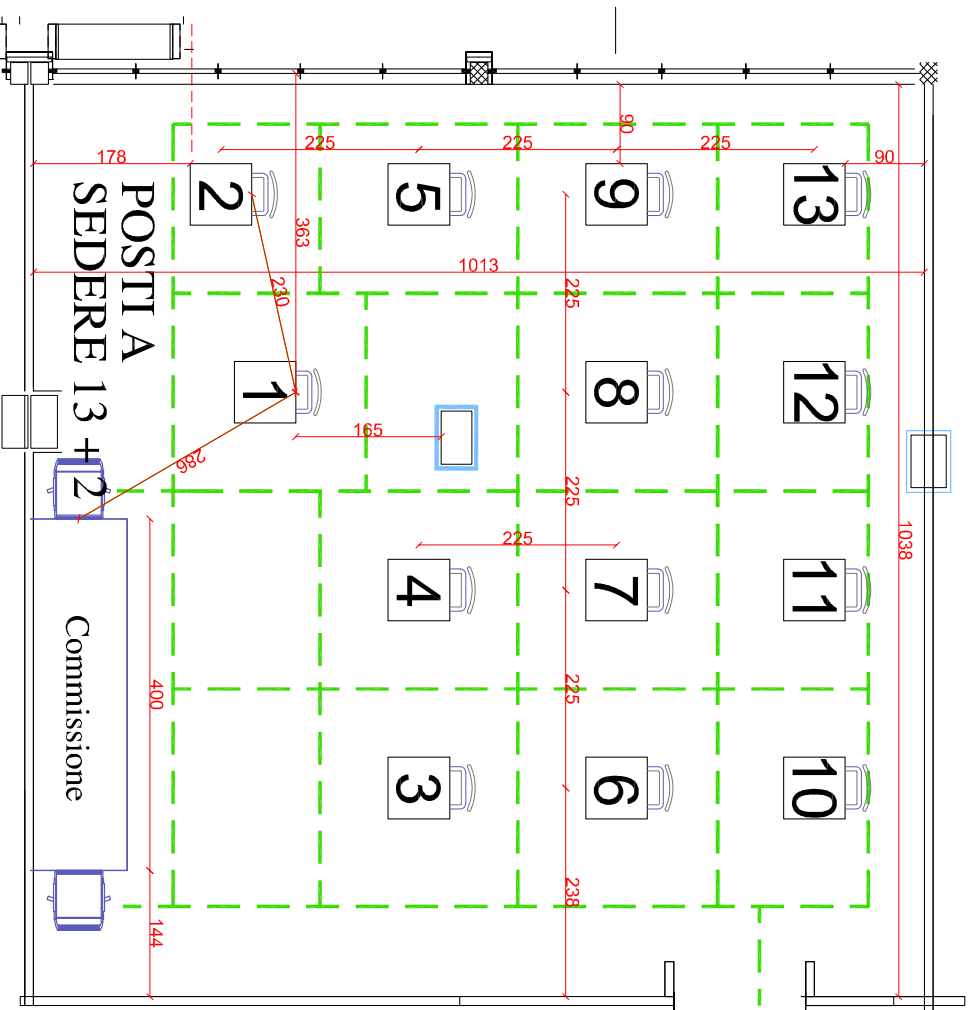

PIANO COVID-19 CONCORSI

Corso Inghilterra 7 - Torino

LOCALE BAR

Capienza: 24 + 2

N.B.: il rispetto delle distanze indicate andrà preliminarmente verificato in loco

LEGENDA

 Percorso principale

 Ingresso sala

 Banchi

 Tavolo commissione

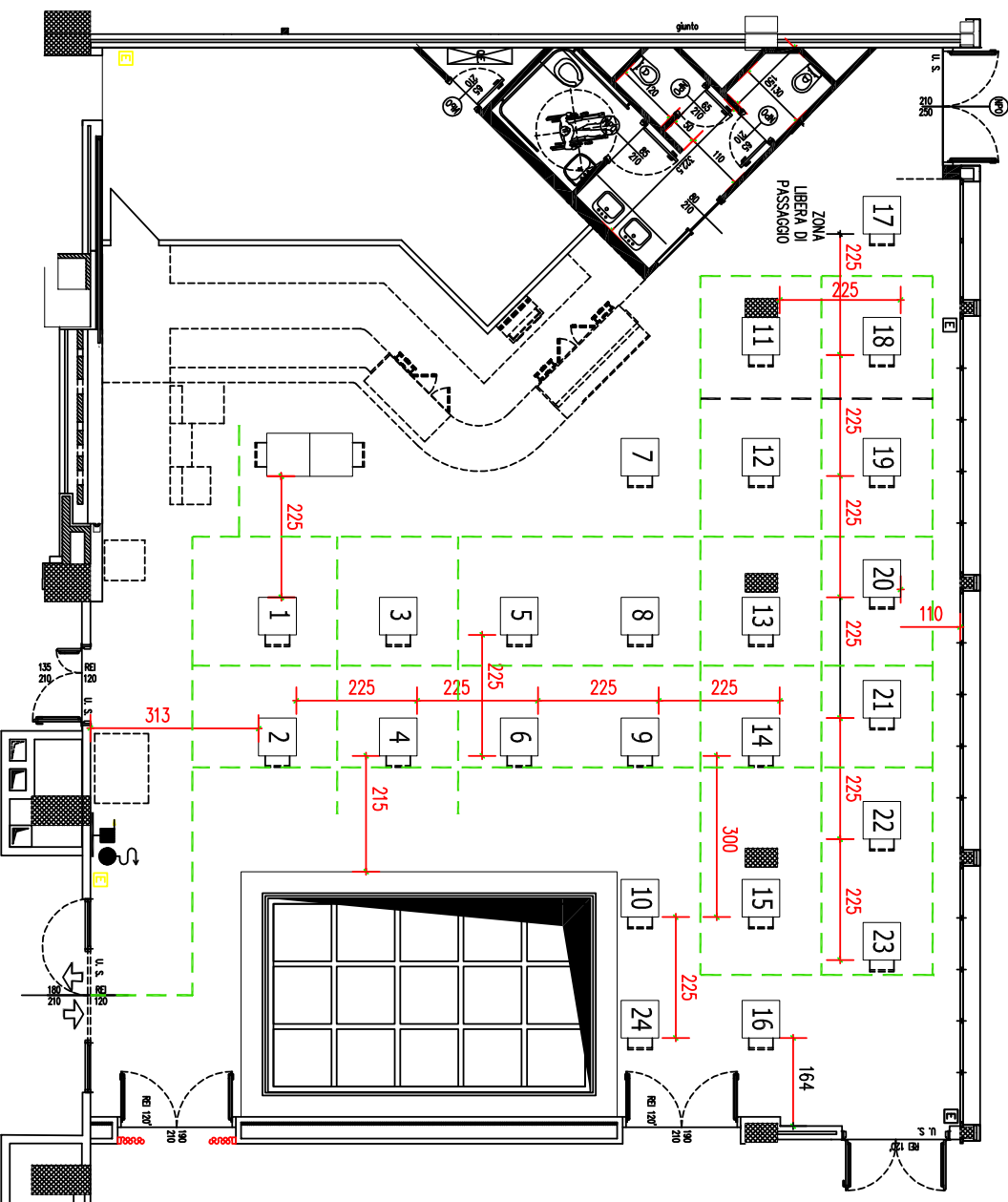

PIANO COVID-19 CONCORSI

Corso Inghilterra 7 - Torino

AREA PRIMO PIANO

Capienza: 14 + 2

N.B.: il rispetto delle distanze indicate andrà preliminarmente verificato in loco

LEGENDA

 Percorso principale

 Ingresso sala

 Banchi

 Tavolo commissione

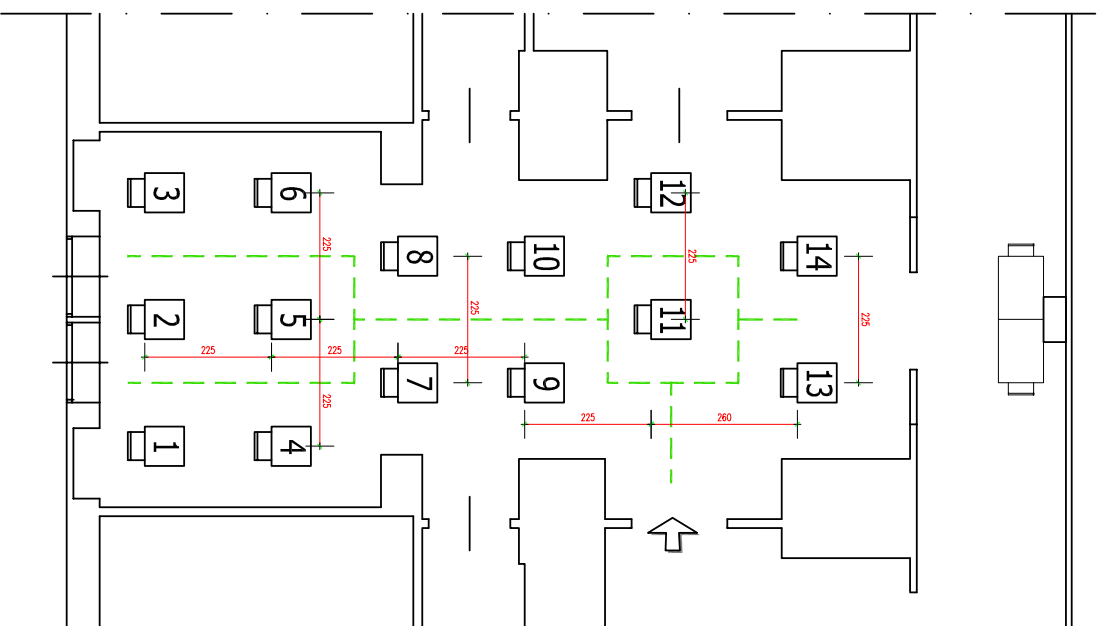

PIANO COVID-19 CONCORSI

QUINDICESIMO PIANO

Capienza: 14 + 2
SALA CONFERENZE

N.B.: il rispetto delle distanze indicate andrà preliminarmente verificato in loco

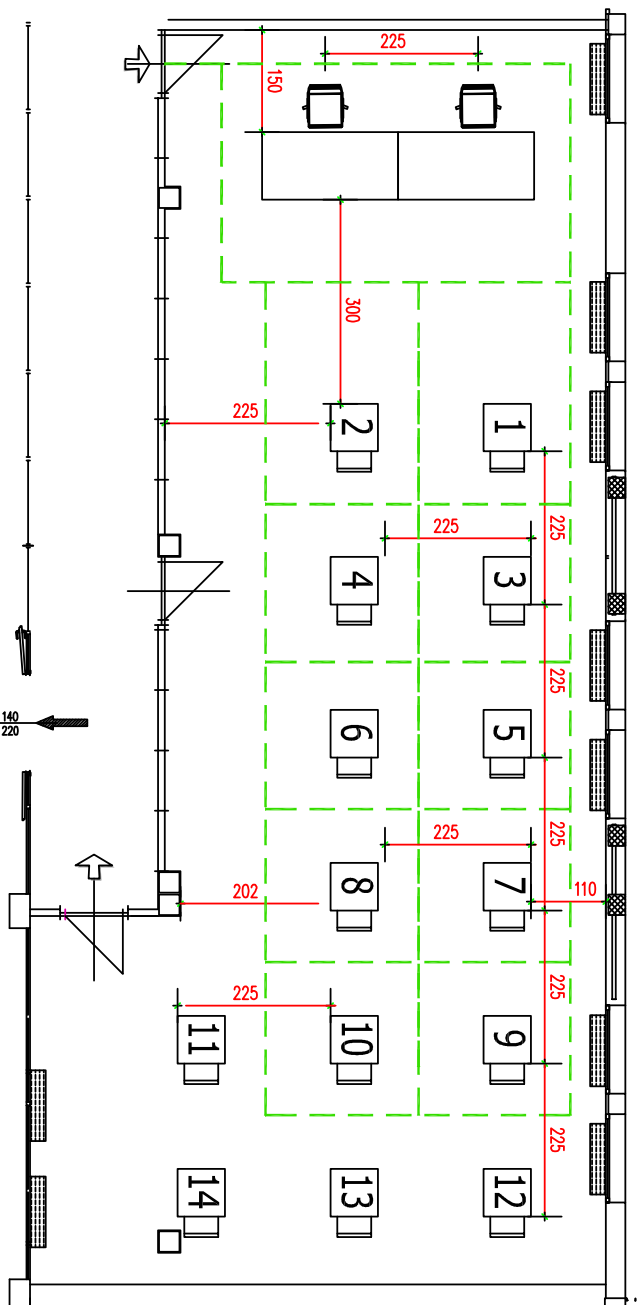

LEGENDA

 Percorso principale

 Ingresso sala

 Banchi

 Tavolo commissione